

Installation Instructions

APRON STRIPS AND FEATURE STRIPS FOR
BJELIN HERRINGBONE PARQUET

Locking system 2G/5G®

BJELIN

Laying instructions for installation of apron strips and feature strips for Bjelin Herringbone Parquet

Please read the installation instructions carefully. If you have any questions, please contact your distributor or Bjelin. Note that these instructions are a supplement to the ordinary laying instructions for Bjelin Herringbone Parquet.

General

You can use the same strip for the apron strip and feature strip that you use to install the herringbone. You can either have a straight across feature strip in the corner or a mitre joined strip. The most important thing is that there is a complete locking groove all around the herringbone that allows you to install the apron strip against the wall.

Straight across feature strip

There are two different ways to install your straight across feature strip. The difference is where you want to place your fitting piece. You can either cut to the last strip as a fitting piece or you can place the fitting piece in the middle.

If you want the fitting piece to be placed in the middle, you connect each corner with an A-strip and a B-strip to produce a locking groove around the entire angle of the floor. You now build from both sides towards the centre. In the centre, you have to cut a locking groove in the same way as described below Routing the Herringbone Border. If there is too little, i.e. less than half, this can be done for 2-3 strips.

However, if you want the fitting pieces on the last strip in the corner, you must measure the floor and calculate the size of the strip so that you get equal amounts of end pieces in the feature strip. Thereafter you must follow the instructions for Routing the Herringbone Border.

Mitre joined feature strip

When you move the corner, you centre the feature strip so that you achieve a level finish. A fitting piece can also be added, according to the instructions in Routing the Herringbone Border, if necessary so that the mitred strips are not too small (no less than half the strip). In the mitre joined corner a groove should be routed in each mitre angle to lock the corner with a loose tongue, using the same router, cut to a 5x7 mm piece that can be glued to create a stable corner.

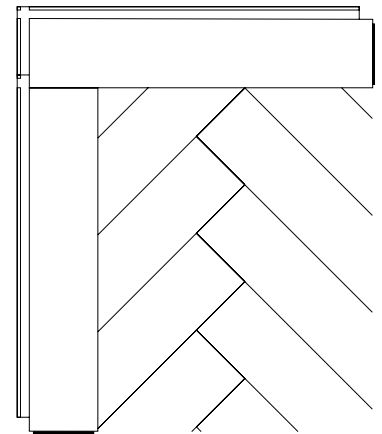

Straight across feature strip

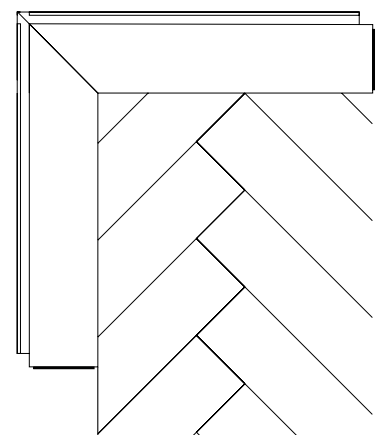

Mitre joined feature strip

Tips when laying

It is a good idea to use A-strips for feature strips and B-strips for apron strips, or vice versa.

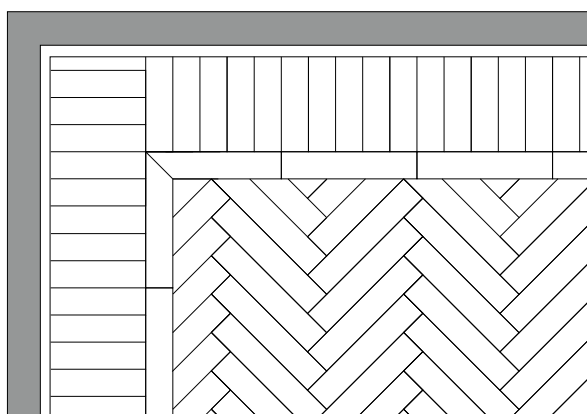

Mitre joined feature strip with straight apron strips

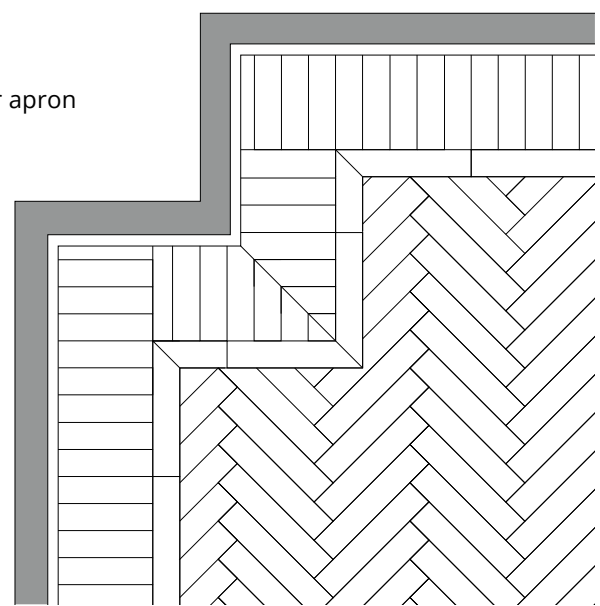

Mitre joined feature strip with mitre joined and straight apron strips.

Recommended tools

- Pencil
- Folding rule
- Plunge saw with guide rail
- Hand router
- Router bit
- Wood glue (D3)

Routing the Herringbone Border

Step 1

Mark where the feature strip should be on the floor with a pencil (a suitable distance is approx. 1 strip). Check that the floor and apron are centred with each other. Add 8 mm and cut off the excess material on the strips.

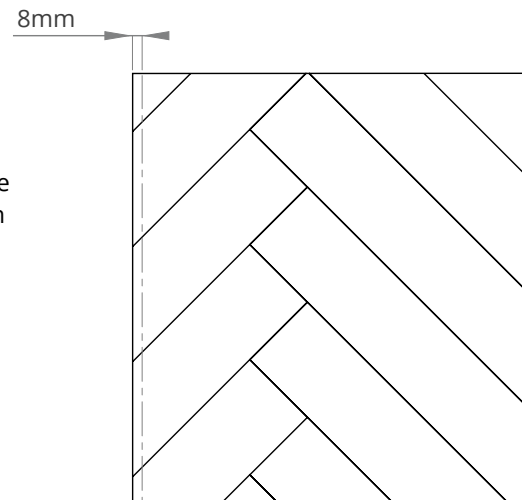

Step 2

Adjust the saw depth to 10 mm (precisely) and cut to the finished measurement, i.e. 8 mm from the outer edge (make sure you have a fine blade on the saw to avoid kickback). Saw once more around the floor, 2 mm from the outer edge. You can then easily break off the excess material.

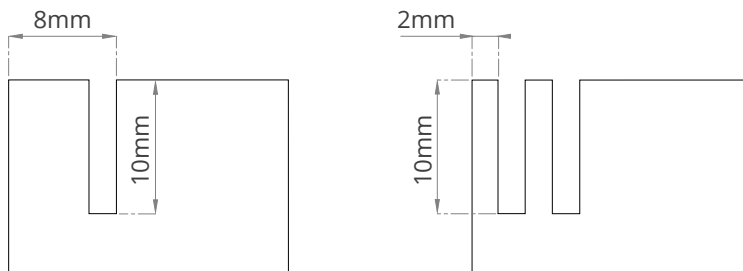

Step 3

Set the router bit to a depth of 10.7 mm (precisely). Then route all sides of the floor. (Router bit = rabbeting router bit L=5 F=4 D=36 S=8)

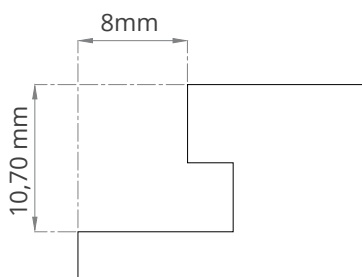

Step 4

Glue the strip to the bottom and top of the tongue. Be sure to wipe off any excess glue. Place a few weights on the feature strip to produce an even level for the floor.

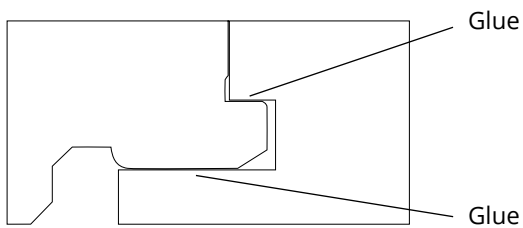

Step 5

Measure the distance between the feature strip and the wall including the wall distance and adjust the apron strip. Now simply click the apron strip into the feature strip.

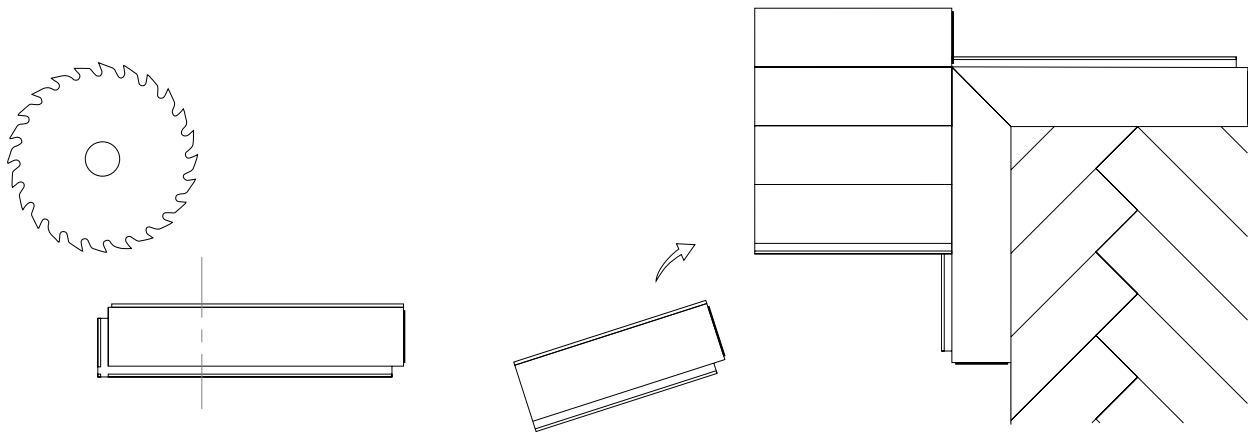

Further information

For further information or if you have any questions regarding the installation of your Bjelin wooden floor, please do not hesitate to contact us at sales@bjelin.com.